



ALL SEASONS

WINDOW & DOOR MFG., INC.™

Double Door Storm Installation Instructions

3/1/06

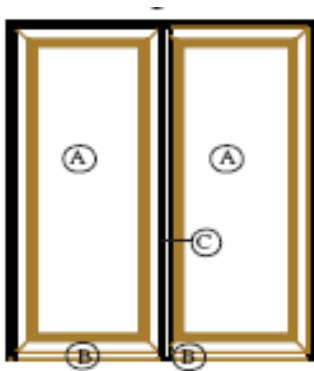

Tools Required

- Electrical Drill
- Hacksaw
- 3/32" Drill Bits
- 5/16" Drill Bits
- Knife
- Tape Measure
- Saw Horses
- Stiff Putty Knife
- Pencil
- Square
- Flat & Phillips Screw Driver
- Level
- Pliers
- Hammer

Fitting the Door to the Opening

1. Take an outside measurement of the opening height to accommodate the slope of your sill.
2. With the door in the closed position, place it in the opening and check

Holding the continuous header z-bar in place, drill a 3/32" pilot hole into the top trim board or brickmold through header mounting hole. Fasten the header firmly in place at both ends using (2) #6 x 1" screws.

the fit.

3. Holding the continuous header Z-bar in place, drill a 3/32" pilot hole into the top trim board or brickmold through header mounting hole. Fasten the header firmly in place using your installation screws.

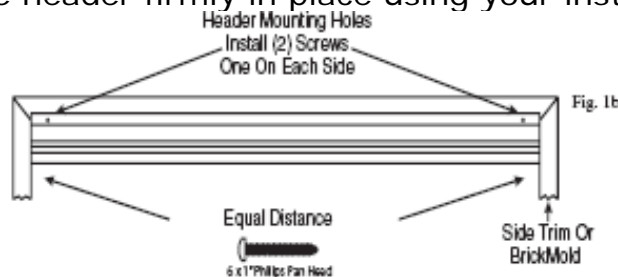

DO NOT INSTALL REMAINING SCREWS AT THIS TIME

4. Mark and cut both Hinge and Lock side Z-bars at a slight slope to the outside. The Z-bars need to be cut 1/8" shorter than the opening that it

will be installed in.

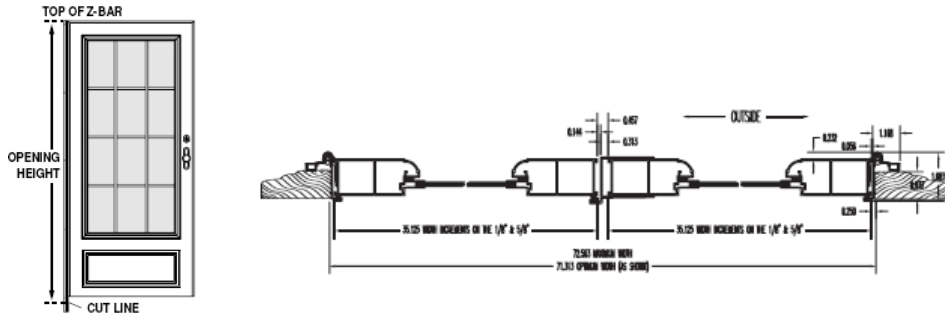

5. With the door in the closed position, place it in the opening and push the hinge side of the door tightly against the jamb. Secure it with screws. The tighter you get it against the wood, the better. Install the screws along the full length of the hinge side Z- bar jamb and Z-bar header before removing the shipping clips located at the top and bottom of the latch side Z-bar jamb.
6. Open the door and install two jamb screws at each hinge. Note: These screws are installed perpendicular to the ones already installed on the outside of the hinge Z-bar and will be hidden from view when the door is closed. (Note: Location and tension on these screws will torque the Z-bar hinge side jamb and adjust the clearance between the latch side Z-bar and the door slab on the opposite side of the door.) Use a level to make sure the Z-bar runs straight up and down. Repeat the same steps for the other door on the opposing side making sure the doors are both even with each other at the top.

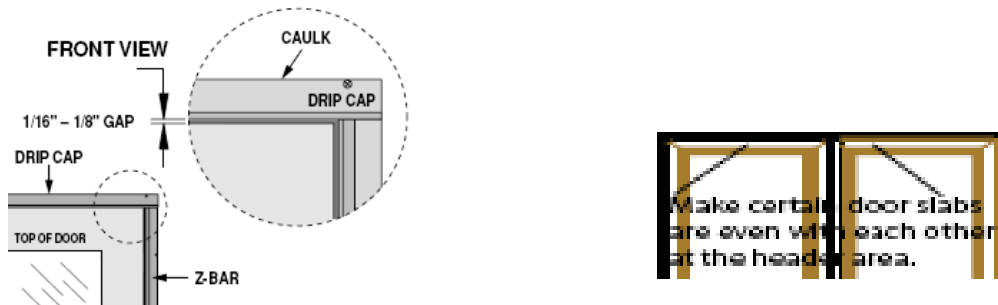

7. Leave an 1/8" gap between the latch-side Z-bar and the door frame.
8. Make sure that there is adequate weatherstripping contact along the full length of the latch side Z-bar. Either adjust the latch side Z-bar or install additional screws (or tighten or loosen the screws already installed) in the hinge side Z-bar (as noted in #5 above) to adjust the clearance.

Installing the Astragal

- Step 1 - Measure the active door height from the exterior, including the bottom expander. Use this dimension to cut the astragal.
- Step 2 - Determine which end will be the bottom of the astragal. The weatherstripped flange will be to the inside allowing the active door to seal against it. The notch for the expander will be at the bottom. You will need to cut off the top.

Note: The astragal is approximately 7 inches longer than needed and notched for the bottom expander at both ends. This allows it to be used for a right or left hinged door.

- Step 3 - Measure the astragal including the bottom tongue. Cut the astragal to length. Notch the top of the weatherstripping flange (1/4" to 5/16") see Fig. 1h. Slide the astragal onto the fixed door flush with the top.
- Step 4 - Close the fixed door and make sure the flange notch clears the inside z-bar. From the outside, close both doors and adjust the astragal to an 1/8" margin.
- Step 5 - Measure the fixed door width from the exterior, including the tongue of the astragal. Cut the bottom expander to this dimension.

Note: Cut the hinge side end of the expander. This leaves the factory edge against the astragal.

- Step 6 - Slide the bottom expander into place. Check the door for operation and margins. Secure the astragal and expander in place with #6 x 1/2" color matched screws and 3/32" pilot holes.

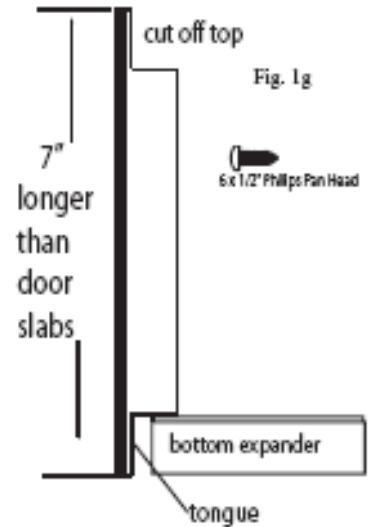
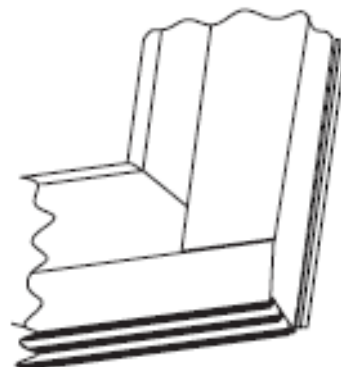

Notes

Superview doors only:

Cut 1" from the tongue at the bottom of the astragal before final cut of the astragal.

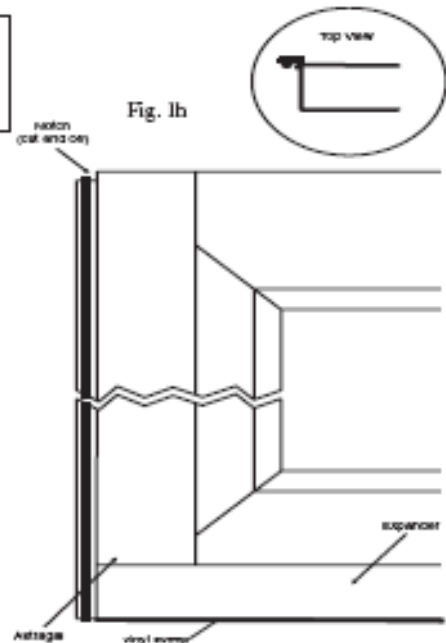

Installing the Expander Sweep

1. Slide the bottom expander off the door.
2. Once you have the vinyl sweep in place, crimp the metal channels closed, then cut off the excess vinyl sweep.

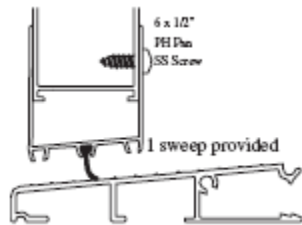

3. Slide the expander down so it touches the entire length of the sill.
4. Install two screws to hold the expander firmly in place.

Installing the Slider Bolts to fixed door

- Step 1 - To locate the slide bolt at the sill, position the keeper on the sill, close the door and hold the slide bolt against the door so that the body of the slide bolt clears the keeper.
- Step 2 - Operate the slide bolt so that the pin is fully engaged in the keeper. The exact location of the slide bolt depends upon the location of the door expander and that the bolt is mounted high enough to clear the keeper and is also fully engaged in the keeper.

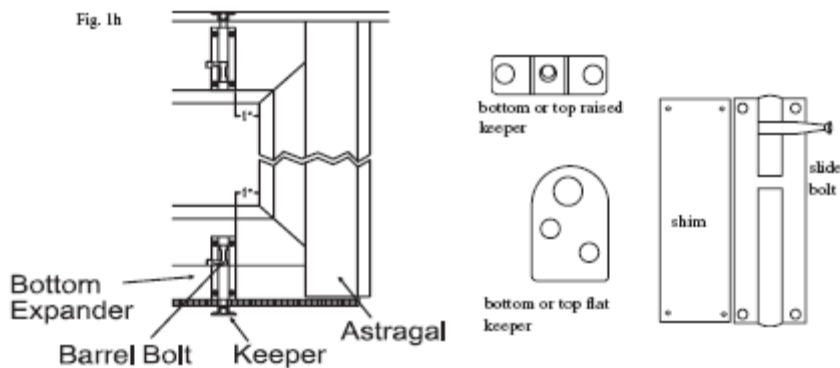

Note: If there is not enough space to mount the slide bolts as illustrated, the slide bolt will need to be moved towards the corner of the door until there is sufficient space.



- Step 3 - Drill a 3/32" pilot hole through the door frame (screw should not be placed at the miter seam of panel) and install #6 x 1/2" screw. Repeat 3 times.
- Step 4 - Mount the header slide bolt at the top of the fixed door and use the shim for under the slide bolt so the bolt clears the header z-bars weatherstrip flange, (1" from inside edge of door stile) (see Fig 1h).

Installing the Latch

Depending on the style of the door you've chosen, hardware may

differ. If your door is not pre-drilled for the latch, use the template that came with your purchase to drill the latch holes. Keep your drill level and make sure the storm door latch doesn't interfere with the primary door hardware.

1. Use the detailed drawings in the instructions provided by the manufacturer to assemble the latch.
2. If you chose a door with a lock, install the deadbolt.

Installing the Closer Mechanism

1. First, make sure the door opens and closes freely. Adjust if necessary.
2. Fasten the doorjamb bracket to the house door frame.

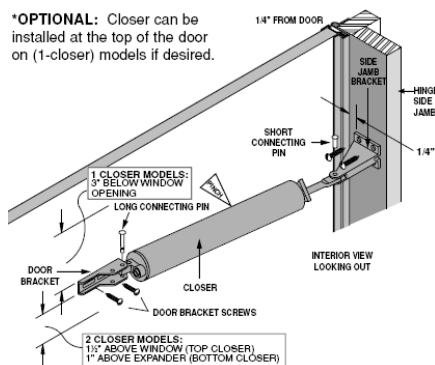

3. Slide the hold-open washer onto the rod.
4. Connect the closer to the jamb bracket with the short connecting pin.
5. With the long connecting pin, attach the door bracket to the front hole of the closer tube.
6. From inside your home, with the door in the closed position, level the closer and mark the location for the bracket. Fasten the door bracket to the door with 5/8" screws.
7. To slow the door's closing, adjust the bypass valve on the door's closure mechanism until it closes at a speed you like.

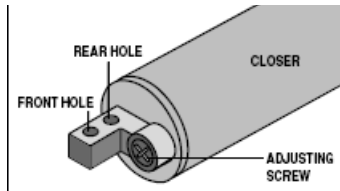

8. Mount the safety chain, if included with your door, to allow a 90-degree opening of the door.

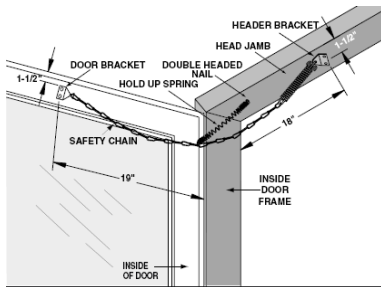

Storm Door Warranty Limitations:

- Modification of door will void warranty.
- Screen/glass damage or breakage is not covered under warranty.
- Wind damage is not covered under warranty.
- Warranty applies to original homeowners of owner-occupied residential properties and covers manufacturer's defects.
- Labor cost, reinstallation fees are not covered by warranty.

NOTE: Warranty applies to original owner—only. Proof of purchase is required.



ALL SEASONS
 WINDOW & DOOR MFG., INC.™

400 Ambassador Row
 Longview, Texas 75604
 1-800-752-7274