

STORM DOOR

Choose from:

- Full-View or Self-Storing Ventilating construction
- A wide selection of standard sizes in stock or order your Custom Size Door
- Bronze, White, or Sandstone colors of durable, baked-on paint finishes
- Tinted Glass is highly recommended
- Energy Efficient Low-E Glass also available in the insulated glass full view

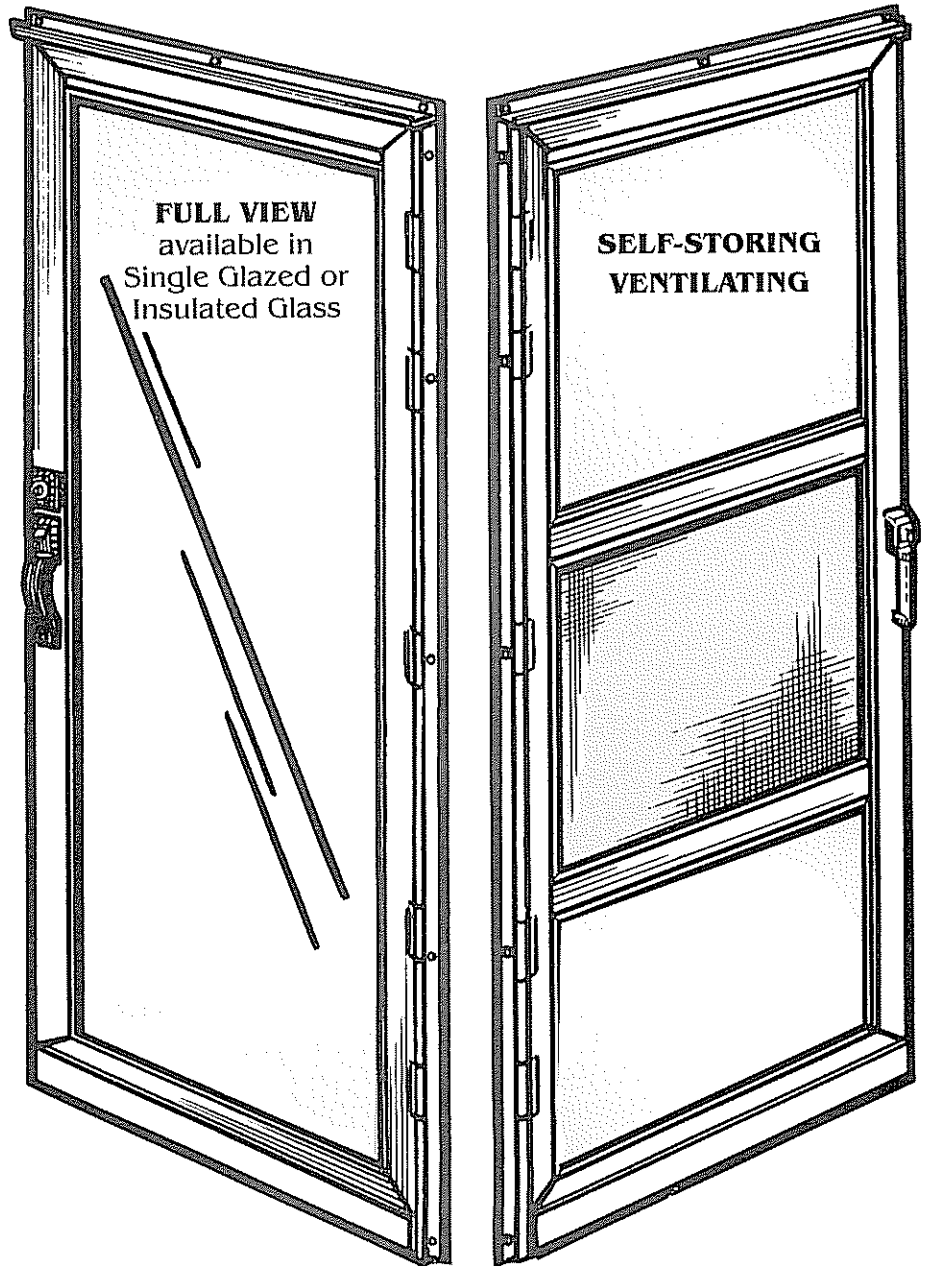

ALL SEASONS
WINDOW & DOOR MFG., INC.
Longview, TX www.allseasonswindows.com

DESIGNER HANDLE SELECTION

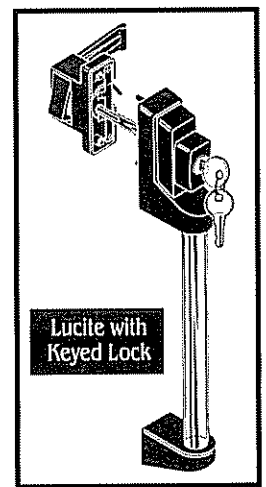
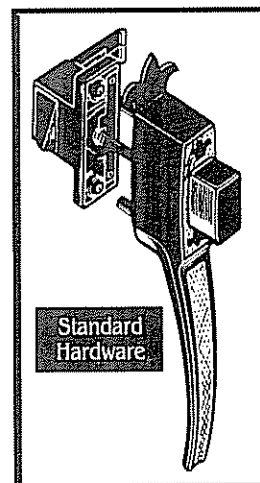
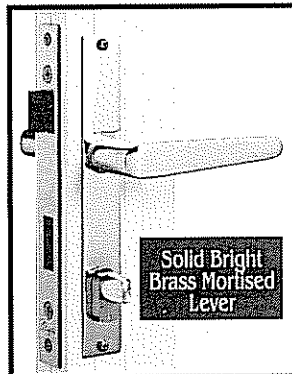

SELF-STORING STORM DOOR FEATURES

Massive, strong corner gusset

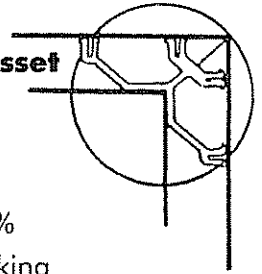

Heaviest Z-bar in the industry:

1. Interior trim for a finished look
2. Increases strength of Z-bar by 300%
3. Acts as lock keeper for a better looking installation & improved door operation (eliminates need for separate striker plate)

Heavy Duty 1 3/8" x 3 1/8" thick extruded main frame - Full View
1 3/8" x 2 1/2" - Self-Storing

Sash are fully weatherstripped on all four sides - reducing air, dust, & pollen infiltration

Sash are interlocked for less air infiltration

Screen expander to further reduce air infiltration

Durable Metal corner inserts & latches - *not plastic*

Sash are reversible for top ventilation

Cross rail weeps to the outside - *not inside*

5 Extra Large brass bearing oilite hinges with massive steel pins, strategically placed at stress points

Both Z-bar & hinge are machined to within .005" - Machined fit keeps the door from sagging

Sash are marine glazed

1 1/2" wraparound expander with extra wide vinyl sweep further reduces air infiltration

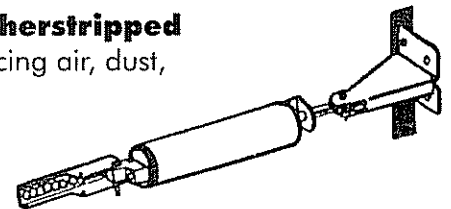

Extra Large, Heavy Duty 1 1/2" pneumatic closure, windchain & installation screws included

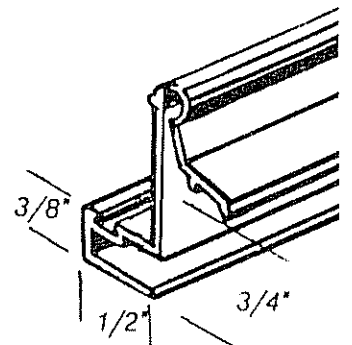

3/4" eliminates need for build-out; for a neater, faster, less costly installation

Quality & Service
SINCE 1979



ALL SEASONS
WINDOW & DOOR MFG., INC.

Longview, TX www.allseasonswindows.com