

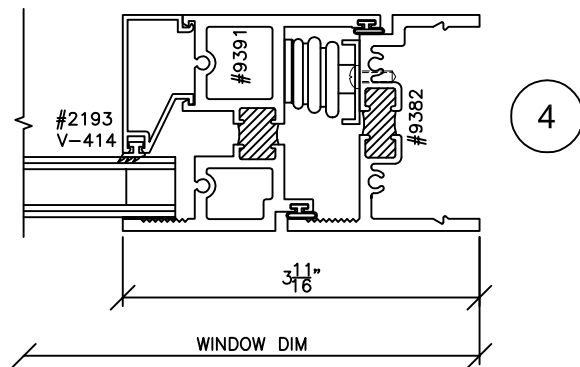

TITLE	TEST	RATING				
SERIES 5125 PROJECT IN THERMAL WINDOW SYSTEM ELEVATIONS	STRUCTURAL	HC-70			SCALE: 3/8" = 1'	
					PAGE NUMBER: 1 OF 5	
	COMPATIBLE SERIES:	5125 CSO, 5125 FF, 5125 PO				

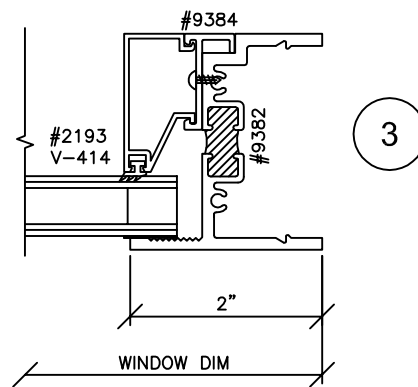

TITLE	TEST	RATING	
SERIES 5125 PROJECT IN THERMAL WINDOW SYSTEM HEAD, JAMB, & SILL DETAILS	STRUCTURAL	HC-70	
COMPATIBLE SERIES:	5125 CSO, 5125 FF, 5125 PO		SCALE: HALF
			PAGE NUMBER: 2 OF 5

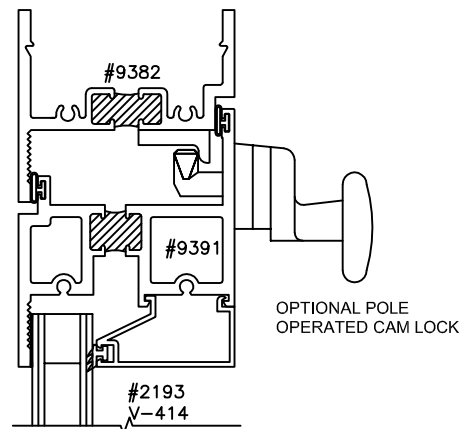
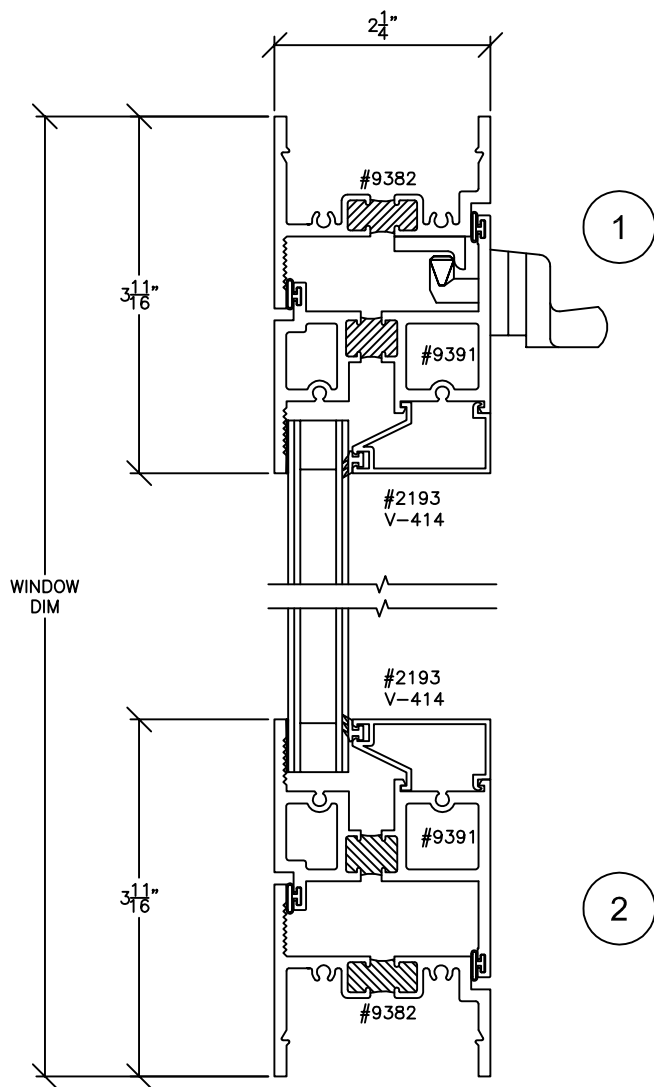
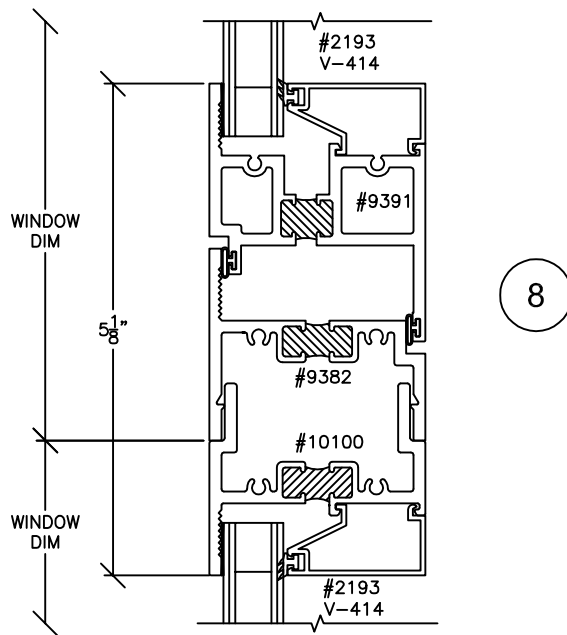
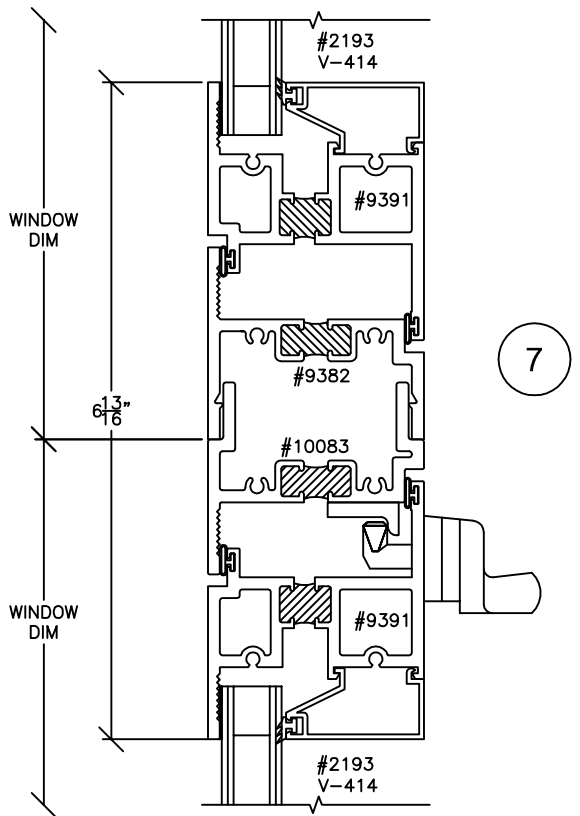
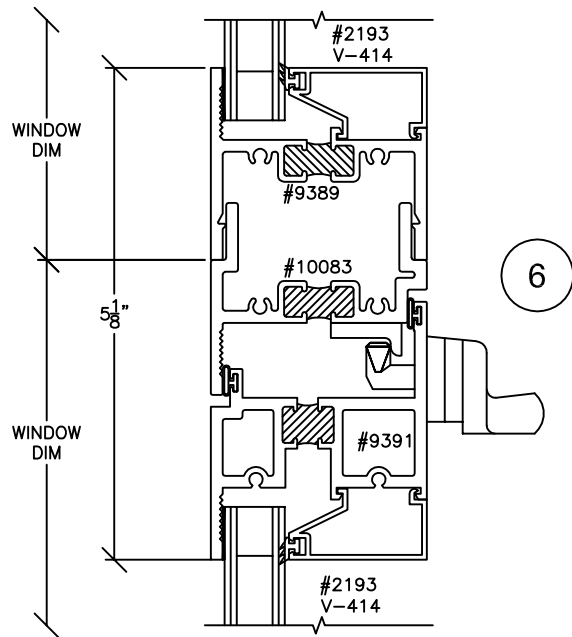
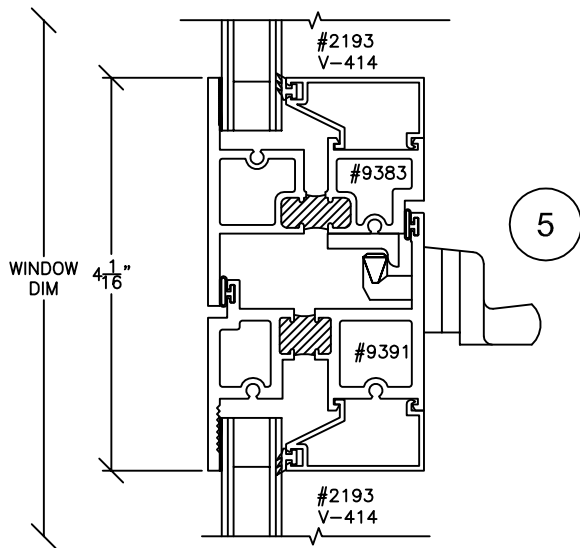

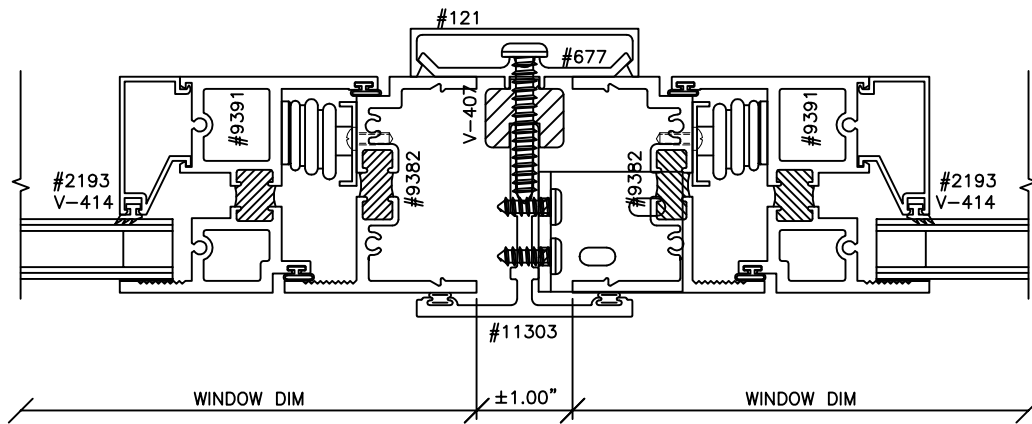

TITLE	TEST	RATING				
SERIES 5125 PROJECT IN THERMAL WINDOW SYSTEM STACK DETAILS	STRUCTURAL	HC-70			SCALE: HALF	
					PAGE NUMBER: 3 OF 5	
	COMPATIBLE SERIES:	5125 CSO, 5125 FF, 5125 PO				

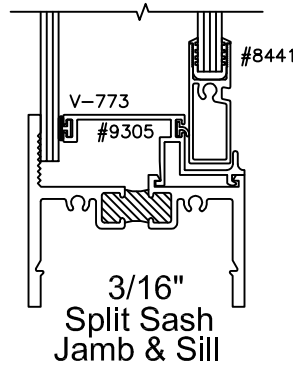
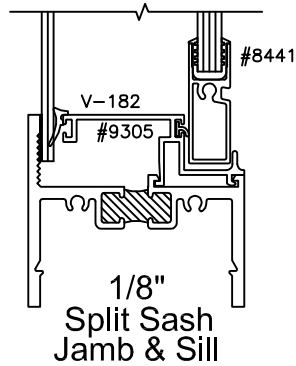
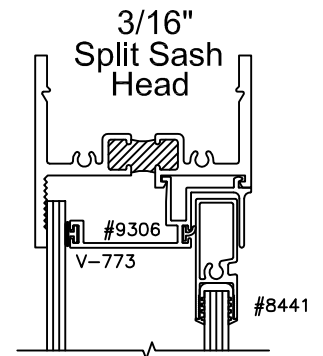
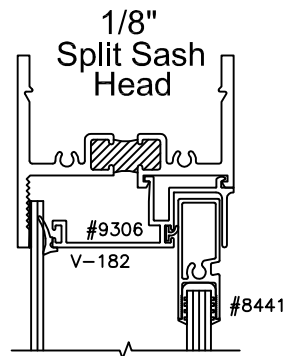
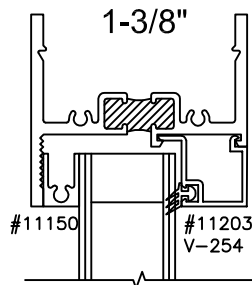
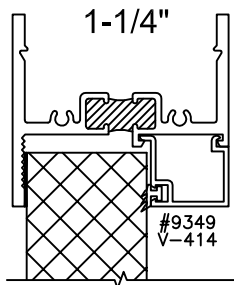
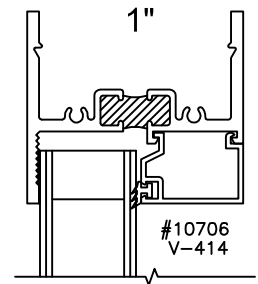
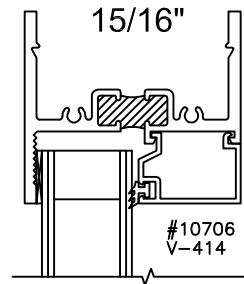
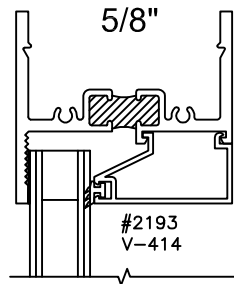
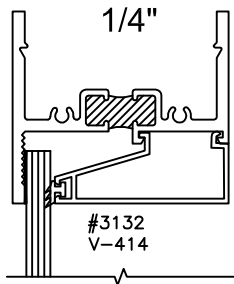

9

TITLE	TEST	RATING				
SERIES 5125 PROJECT IN THERMAL WINDOW SYSTEM MULLION DETAIL	STRUCTURAL	HC-70			SCALE: HALF	
	COMPATIBLE SERIES:	5125 CSO, 5125 FF, 5125 PO			PAGE NUMBER: 4 OF 5	



TITLE	TEST	RATING				
SERIES 5125 PROJECT IN THERMAL WINDOW SYSTEM GLAZING OPTIONS	STRUCTURAL	HC-70				
	COMPATIBLE SERIES:	5125 CSO, 5125 FF, 5125 PO				
		SCALE: HALF	PAGE NUMBER: 5 OF 5			